



ASTRO

RÉUNION

FOR ALL YOUR
SMALL OR BIG
MEETINGS

Executives spend 16 years of their lives in meetings! With occasional and conference tables of modular size and shape, Buronomic helps you create a meeting space to suit your mood and requirements and make those 16 years as productive and comfortable as possible.



ASTRO RÉUNION

SOBRE

Offering a wide range of dimensions, top sizes and extensions, Astro meeting tables can be combined easily according to the requirements of your business and the spaces available. The numerous composition options meet individual or workgroup requirements (extra workstation, training room, meeting, etc.). An aesthetic complement to Astro Reunion is a transverse modular solution for any office.



Details

1. Modern and minimalist style of the arch metal leg with raised top. 2. Magnetic cable down-guide designed especially for the leg.



Materials and warranty

Our industrial know-how guarantees the quality and durability of the materials used to make our furniture.

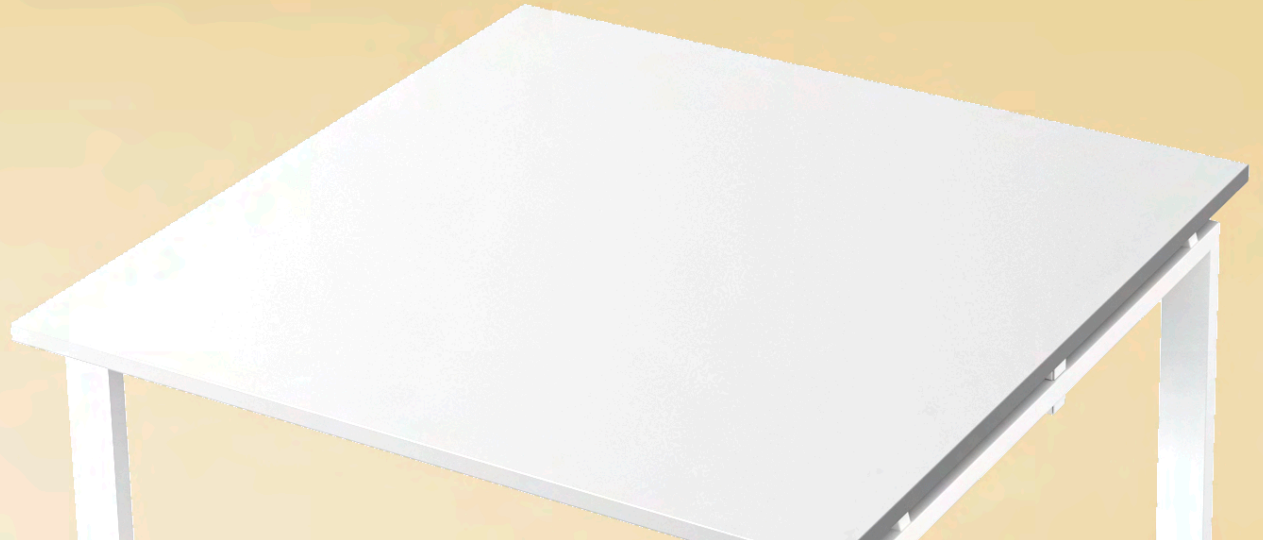

STRUCTUREX® PANELS

Full panels of particles with melamine surfacing. Counter-balanced and treated against reflection. Thickness 16 to 25 mm. Density 680 kg/m³ for the 25 mm panels. Tested as conforming to abrasion and hot & cold water resistance to the XP D60-050 standard.



5 YEAR GUARANTEE

The quality and durability of the materials enable us to guarantee all our ranges for 5 years under normal conditions of use.



NF OFFICE EXCELLENCE CERTIFIÉ

The mark of excellence, guarantee of Buronomic's commitment in a corporate social responsibility approach that focuses on people.

+ More details

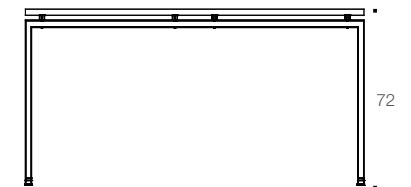
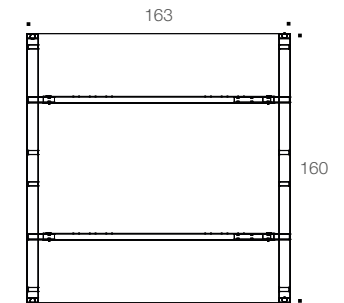
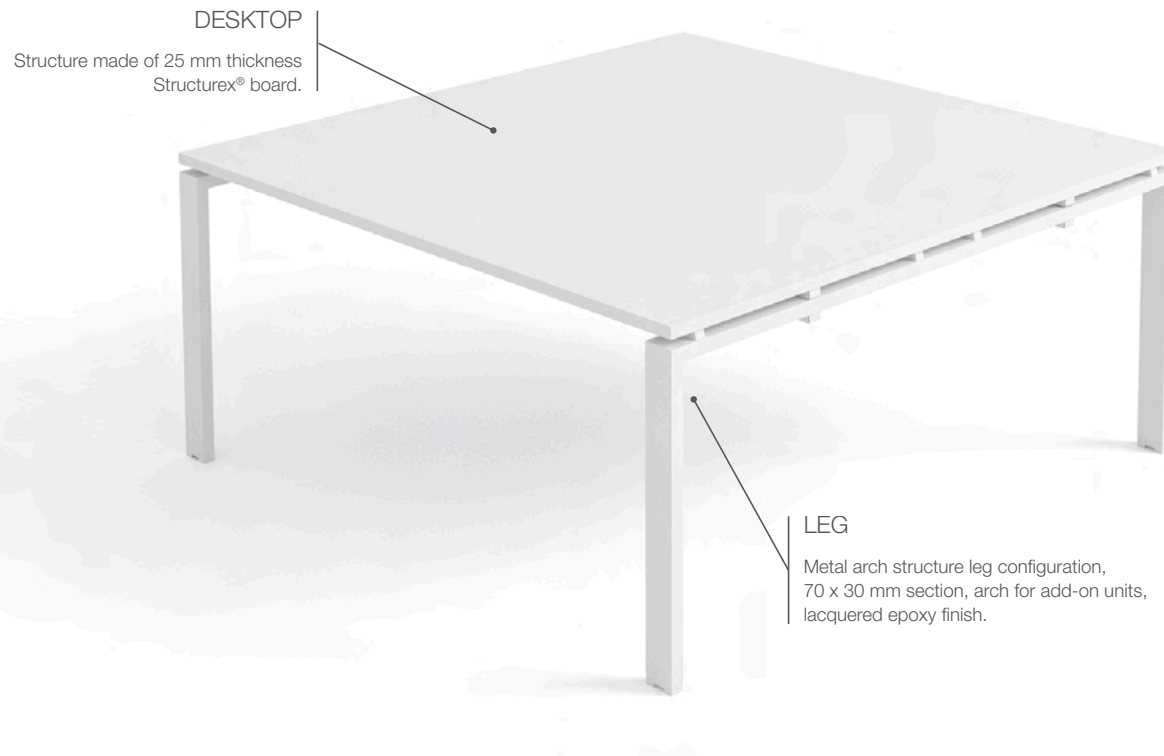

Technical description

- Structure made of 25 mm thickness Structurex® board.
- 2 mm ABS edging.
- Metal arch structure leg configuration, 70 x 30 mm section, arch for add-on units, lacquered epoxy finish.
- Recessed leg on add-on unit to ease lateral movement.
- Astro range is based on a self-supporting beam system with raised desk tops, forming a full steel underframe with 2 arch legs and a transverse beam.
- Adjustable screw jacks to compensate for any defects in the floor.
- Suspended "D end" extension fixed beneath the top by 4 metal bars.

Finishes

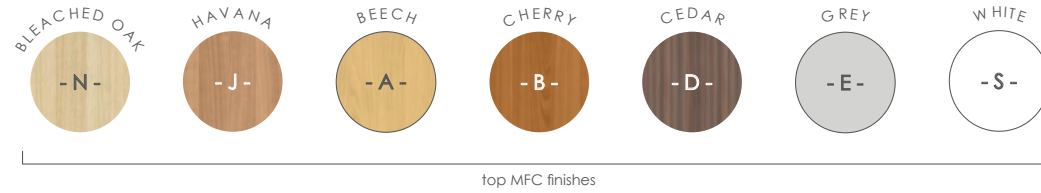
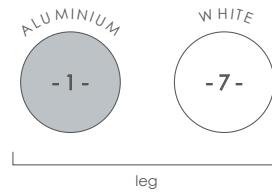

Tables

L 120 CM TABLE

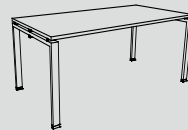

Dimensions in cm	Ref.	+ Finishes
D 60 / H 72 / L 120	AK58	+ [] [] []

SQUARE TABLE

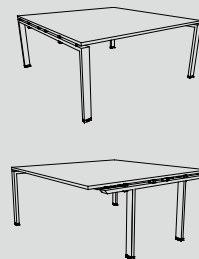

Dimensions in cm	STARTER ELEMENT		ADD-ON UNIT	
	Ref.	+ Finishes	Ref.	+ Finishes
D 163 / H 72 / L 160	AK26	+ [] [] []	AK89	+ [] [] []

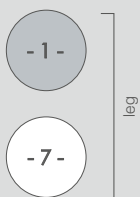

leg

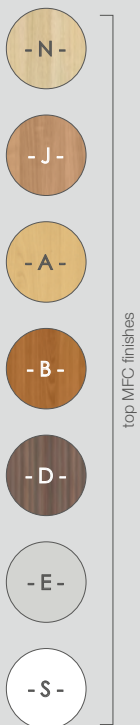

top MFC finishes

Tables

L 140 CM
RECTANGULAR TABLE

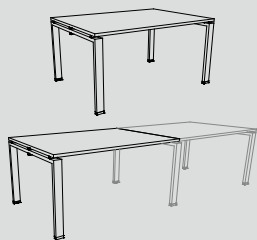

L 200 CM
RECTANGULAR TABLE

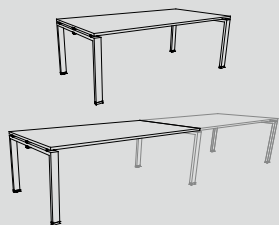

Dimensions in cm	STARTER ELEMENT		ADD-ON UNIT	
	Ref.	+ Finishes	Ref.	+ Finishes
D 100 / H 72 / L 140	BM62	+ []	BM63	+ []
D 100 / H 72 / L 200	BM64	+ []	BM65	+ []

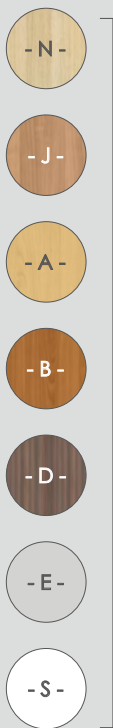

top MFC finishes

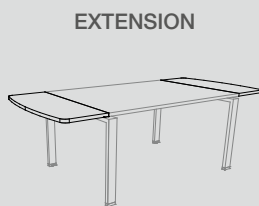

Options

Description	Dimensions in cm	Ref.	+ Finish
Set of 2	D 100 / L 40	BM663	+ L



FIND YOUR LOCAL DEALER

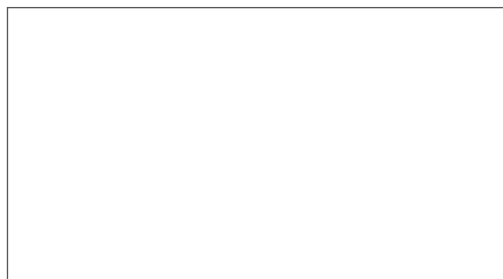

WWW.BURONOMIC.COM